

ABERDEEN

96421...

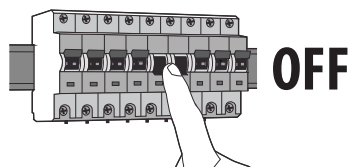

①



②

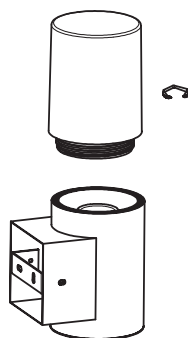

③

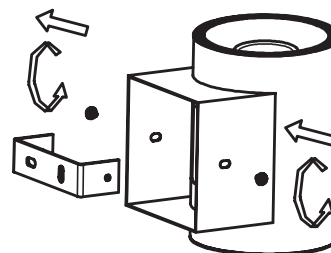

④

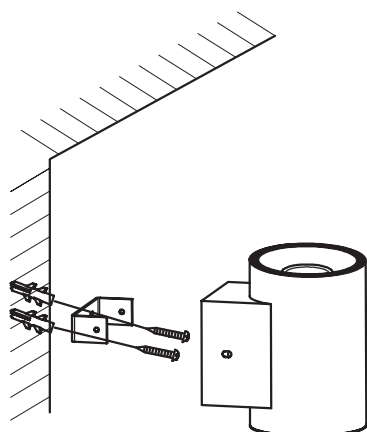

⑤

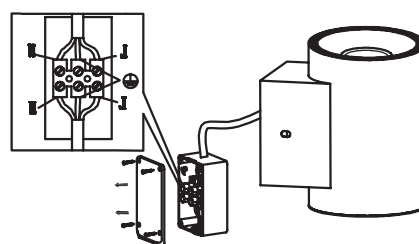

⑥

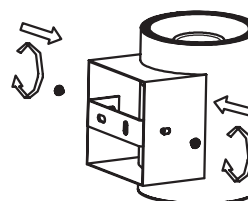

⑦

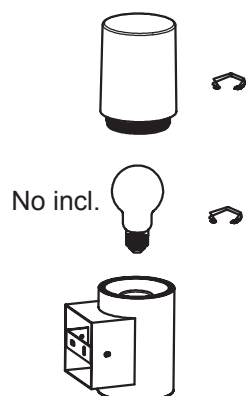

⑧

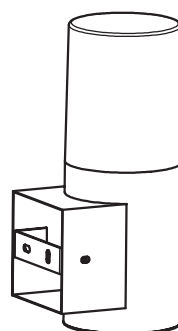

⑨

